

Single-lever bath mixer with stand pipe for free-standing assembly with hand shower set - Chrome

TARA

25 863 661















Fits: TARA, META

- spout: circular, air-enriched flow
- max. flow 19.5 l/min at 3 bar flow pressure
- Hand shower: COMPACT RAIN, max. flow rate 6.8 l/min (at 3 bar)
- bar-type hand shower with anti-scale system
- pivotable spout 360°
- 281mm projection
- wall bracket
- automatic bath/shower diverter
- total height 1031 - 1101 mm
- stand pipe height 565 - 635 mm
- height up to aerator 899 – 969 mm
- slide-on rosettes Ø 135 mm
- metal shower hose 1250mm with integrated anti-twist protection
- WRAS 2001027

**Note: Local building codes may require the use of an anti-scald device. Please refer to remote pressure balance valve (35 910 970 90) Intrinsic protection against back flow.**

Note: Local building codes may require the use of an anti-scald device. Please refer to remote pressure balance valve (35 910 970 90)

Intrinsic protection against back flow.

	Chrome	25 863 661-00
	Brushed Platinum	25 863 661-06
	Dark Chrome	25 863 661-19
	Light Gold	25 863 661-26
	Brushed Light Gold	25 863 661-27
	Brushed Durabronze (23kt Gold)	25 863 661-28
	Matte Black	25 863 661-33
	Brushed Bronze	25 863 661-42
	Brushed Champagne (22kt Gold)	25 863 661-46
	Champagne (22kt Gold)	25 863 661-47
	Brushed Chrome	25 863 661-93
	Brushed Dark Platinum	25 863 661-99

Required miscellaneous



- Concealed floor mounting -**
- max. recess depth 150 mm
  - min. recess depth 80 mm

35 949 970-90  
0010

Single-lever bath mixer with stand pipe for free-standing assembly with hand shower set - Chrome

TARA

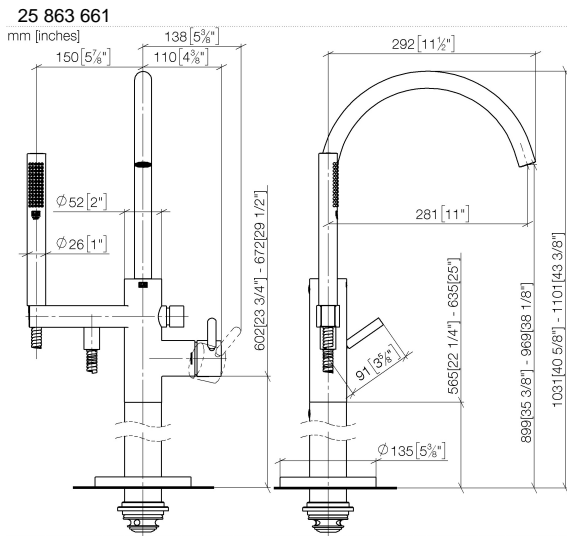

Flow rate chart

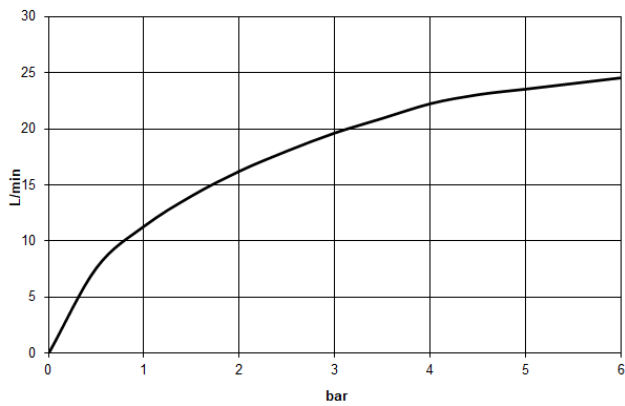

Codes & Standards

ASME  
A112.18.1/CSA  
B125.1

California Energy  
Commission  
(CEC)



Single-lever bath mixer with stand pipe for free-standing assembly with hand shower set - Chrome

---

TARA

25 863 661

Certificates

---

IAPMO\_4976 (5). Belgaqua\_19\_77\_27. WRAS\_2001027. LGA\_29727.

Single-lever bath mixer with stand pipe for free-standing assembly with hand shower set - Chrome

TARA

25 863 661

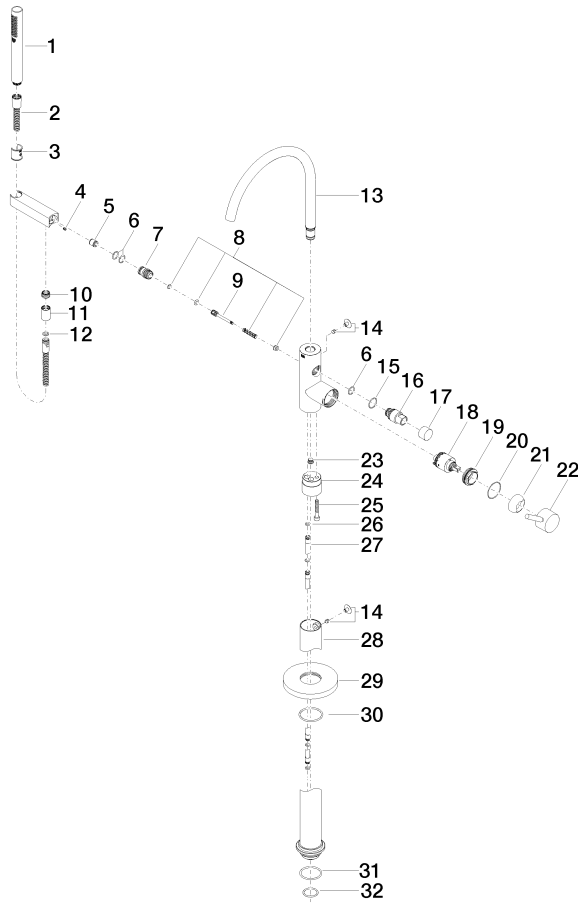



## Single-lever bath mixer with stand pipe for free-standing assembly with hand shower set - Chrome

TARA

25 863 661

### Spare parts list

No.	Item Number	Name	Quantity used	Delivery time
1	90 12 11 140 30-00	shower	1	10
2	90 30 02 072 00-00	Metal shower hose 1/2" x 3/8" x 1250 mm - Chrome	1	10
3	09 18 40 118 90	sleeve	1	2
4	09 31 11 058 90	pin	1	2
5	90 23 01 141 00 90	back-flow preventer	1	2
6	90 14 10 010 00 90	seal	3	2
7	09 24 03 153 20-00	nipple	1	10
8	90 16 02 023 00 90	spring	1	2
9	09 31 09 102 20-00	pull-rod	1	10
10	09 24 03 069 90	nipple	1	2
11	90 21 02 069 00-00	cover	1	10
12	90 14 20 026 00 90	seal	1	2
13	90 28 22 327 01-00	spout	1	10
14	04 31 20 036 00 90	plug	2	2
15	09 14 10 112 90	seal	1	2
16	09 21 34 081 20-00	nipple	1	10
17	09 20 88 002-00	handle	1	10
18	90 15 05 039 00 90	cartridge	1	2
19	09 24 04 298 90	nut	1	2
20	09 14 10 037 90	seal	1	2
21	09 28 30 036-00	cover	1	10
22	90 20 66 005 00-00	handle	1	10
23	04 31 20 039 11 90	plug	1	2
24	09 24 03 152 20-00	adaptor	1	10
25	09 30 30 111 90	screw	1	2
26	09 14 10 139 90	seal	2	2
27	04 28 22 025 00 90	connection	2	2
28	04 28 22 030 00-00	pipe	1	10
29	09 27 88 007-00	rosette	1	10
30	90 14 10 129 00 90	seal	1	2
31	09 14 10 084 90	seal	1	2
32	09 14 10 018 90	seal	1	2